



STUFE . STOVES . POÊLES . ÖFEN





“Non vi è fuoco simile alla passione d’amore”

Wekos domina il fuoco con passione, semplicità e creatività per realizzare stufe e cucine che hanno un’anima. Con un lavoro artigianale guidato dalla cura per il dettaglio e dall’amore per il bello, vengono realizzati modelli che dialogano tra tradizione e innovazione e che rappresentano il frutto di una continua ricerca sospesa tra design e funzionalità.

Entrare nelle case, con discrezione e carattere, proponendo elementi d’arredo che espletino le loro funzioni con efficacia, nel rispetto per la natura e che personalizzino il vostro ambiente senza invadenza perché lì i protagonisti siete voi: un obiettivo ambizioso, da raggiungere anche con esperienza.

“There is no fire like passion of love”

Wekos rules over fire with passion and simplicity creating stoves and cookers with a soul.

Ours is an artisan work led by our eye for detail and our love for beauty; our creations combine tradition with innovation and are the result of our continuous commitment in research on both design and functionality.

To enter your world with discretion and yet with character, with furniture pieces that perform their duty efficiently, in the respect for nature; they characterize and blend perfectly into your spaces where you are the protagonist: this is our goal, which we ambitiously aim at achieving strong with our experience.

“Il n’est pas de feu égal à la passion amoureuse”

Wekos domine le feu avec passion, simplicité et créativité pour réaliser des poêles à bois et des cuisinières à bois qui ont une âme.

Par un travail artisanal guidé par le soin du détail et l’amour du beau, nous réalisons des modèles qui dialoguent entre tradition et innovation et qui représentent le fruit d’une recherche continue suspendue entre design et performances.

Entrer au cœur des maisons, avec discrétion et caractère, en proposant des éléments décoratifs qui jouent leur rôle avec efficacité, dans le respect de la nature et qui personnalisent votre intérieur sans être envahissants, parce que les protagonistes, c’est vous : un objectif ambitieux, que seule l’expérience permet d’atteindre.

„Keine Feuer brennt wie das der Leidenschaft“

WEKOS dominiert das Feuer mit Leidenschaft, Schlichtheit und Kreativität um Öfen und Herde mit Seele zu bauen. Mit Handarbeit und viel Liebe zum Detail werden Modelle realisiert, die zwischen Innovation und Tradition dialogisieren und welche das Ergebnis einer ständigen Forschung nach Design und Zweckmäßigkeit verkörpern.

In das Zuhause mit Diskretion und Charakter eintreten, Einrichtungsgegenstände anbieten die effizient arbeiten und dabei die Umwelt respektieren und die Ihr Ambiente persönlich gestalten ohne aufdringlich zu wirken: ein hochgestecktes Ziel, das mit unserer jahrelangen Erfahrung erreicht wird.



Tutti i prodotti WEKOS sono certificati secondo le norme

All WEKOS products are Mark-approved

Tous les produits WEKOS sont certifiés selon les normes

Alle WEKOS Produkte sind zertifiziert

EN 13240:2001/A2:2004

(per stufe e termostufe)
(for stoves and thermo stoves)
(pour poêles à bois et poêles bouilleur)
(für Kaminöfen und wasserführende Heizöfen)

	Stufa - Stove Poêle - Ofen
	Termostufa - Thermo Stove Poêle bouilleur - Wasserführender Heizöfen
	Peso netto - Net weight Poids net - Nettogewicht
	Potenza nominale (utile) - Nominal heat output Puissance nominale (utile) - Nennwärmeleistung
m^3	m^3 riscaldabili - m^3 that can be heated - m^3 maximum chauffée - Beheizbares Volumen m^3
	Potenza resa all'acqua - Water heat output Puissance rendue à l'eau - An Wasser abgegebene Nutzleistung
	Potenza resa all'ambiente - Space heat output Puissance rendue à la pièce - An Raum abgegebene Nutzleistung
	Scarico fumi - Flue Evacuation fumées - Abgasleitung
	Depressione media al camino - Flue draft pressure Dépression moyenne à la cheminée - Durchschnittl. Förderdruck
	Massima pressione d'esercizio - Maximum working pressure Pression maximum de fonctionnement - Max. Betriebsdruck
	Rendimento - Efficiency Rendement - Wirkungsgrad
	Rivestimenti - Coverings Revêtements - Verkleidungen
	Maiolica - Majolica Majolique - Majolika
	Pietra serpentino boccardata - Bush-hammered serpentine Pierre serpentine bouchardée - Aufgerauter Serpentinstein
	Pietra serpentino sabbiata - Sandblasted serpentine stone Pierre serpentine sablée - Sandgestrahlter Serpentinstein
	Piastrelle - Tiles Carreaux - Kacheln
	Spesso metallo verniciato - Thickpainted metal Metal épais verni - Lackiertes Metall

	Emissioni CO (13% O ₂) - CO Emission (13% O ₂) Emission des CO (13% O ₂) - CO Emission (13% O ₂)
	Emissioni polveri (13% O ₂) - Dust Emission (13% O ₂) Emission de poussières (13% O ₂) - Staubemission (13% O ₂)
	Caldala Acciaio Inox 304 - Boiler Stainless steel 304 Chaudière acier inox 304 - Heizkessel Edelstahl 304
	Installazione a Vaso Aperto o a Vaso Chiuso - Suitable for installation with open or closed expansion tank - Installation à vase d'expansion ouvert ou à vase d'expansion fermé - Installation offenes Gefäß oder geschlossenes Gefäß
	Focolare / Spazio utile focolare - Hearth / Useable space hearth Foyer / Espace utile foyer - Feuerraum / Nutzvolumen Feuerraum
	Spazio utile scaldavivande - Useable space wood burning oven Espace utile chaud des aliments - Nutzvolumen Backofen
	Consumo legna / Lunghezza legna - Wood consumption / Length of firewood Consommation de bois / Longueur de bois - Holzverbrauch
OPTIONAL	
	Ventilazione forzata - Forced air ventilation system Ventilation forcée - Ventilator
	Convogliazione aria posteriore - Rear air conveyor Convoyage air postérieure - Luftstrom hinten
	Scarico fumi posteriore - Rear flue Evacuation fumées postérieure - Rauchgasaustritt hinten
	Scarico fumi a DX - Flue on the right side Evacuation fumées à droite - Rauchgasaustritt rechts

Le caldaie delle termo stufe WEKOS sono costruite in acciaio inox 304. **GARANZIA 10 ANNI.** La garanzia decade nel caso di una non corretta installazione senza i dovuti sistemi di sicurezza. Il kit di installazione non è incluso. **ATTENZIONE!** Non si possono utilizzare gli apparecchi termo senza il circolo dell'acqua all'interno della caldaia.

The boilers used for WEKOS heating stoves are made of stainless steel 304. **10 YEAR WARRANTY.** Incorrect installation or failure to use appropriate safety systems shall render the warranty null and void. The installation kit is not included.

N.B.! Thermo-cookers cannot be used without water circulating in the boiler.

Les chaudières des poêles à eau chaude WEKOS sont construites en acier inox 304. **GARANZIA 10 ANS.** La garantie devient caduque en cas d'installation incorrecte sans les systèmes de sécurité obligatoires. Le kit d'installation n'est pas compris.

ATTENTION! Les cuisinières bouillères ne peuvent pas être utilisées si l'eau ne circule pas à l'intérieur de la chaudière.

Die Heizkessel der wasserführenden WEKOS Heizöfen sind aus Edelstahl 304. **10 JAHRE GARANTIE.** Die Garantie verfällt bei nicht korrekter Installation ohne der vorgesehenen Sicherheitssysteme. Der Installationsbausatz ist nicht inbegriffen. **ACHTUNG:** Die wasserführenden Geräte dürfen nicht ohne Wasserlauf im Heizkessel benutzt werden.

LEGENDA

LEGEND / LÉGENDE / ZEICHENERKLÄRUNG

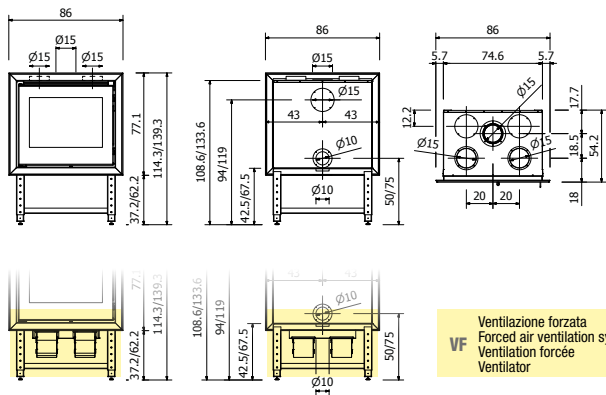















VF Ventilazione forzata
 Forced air ventilation system
 Ventilation forcée
 Ventilator

Design elegante e moderno, la grande porta vetrata permette di gustare pienamente la vista del fuoco che danza, mentre un piacevolissimo calore avvolge la vostra casa. Disponibile con canalizzazione aria a ventilazione naturale convettiva o forzata mediante ventilatori.

An elegant and modern design, as well as a large glass door allowing you to fully enjoy the view of the dancing fire, while a delightful warmth surrounds your home. Available with air channeling system for natural ventilation or forced convection by means of fans.

Avec un design élégant et moderne, sa grande porte vitrée consent de jouir pleinement de la vue du feu qui danse, tandis qu'une chaleur douce enveloppe votre maison. Avec version dotée de canalisation de l'air par ventilation naturelle ou convection forcée au moyen de ventilateurs.

Das elegante und moderne Design mit der großen Feuerraumtür bietet ausreichend Blick auf das tanzende Feuer, während eine angenehme Wärme den Raum einhüllt. Verfügbar mit Luftkanalisation mit natürlichem Abzug oder begünstigt durch Ventilatoren.

	SC 77	
	155 kg	
	7,6 kW	
	170 ÷ 300 m³	
	Ø 15 cm	
	12 Pa	
	80,8 %	
	1289 mg/mc	
	14,5 mg/mc	
	ceramica refrattaria refractory ceramics céramique réfractaire Hitzebeständige Keramik	31 cm 57 cm ↘ 30 cm
	2,5 kg/h – cm 33/50	
OPTIONAL	VF 	
	 	



INSERTO CAMINO SC 77







SC 75

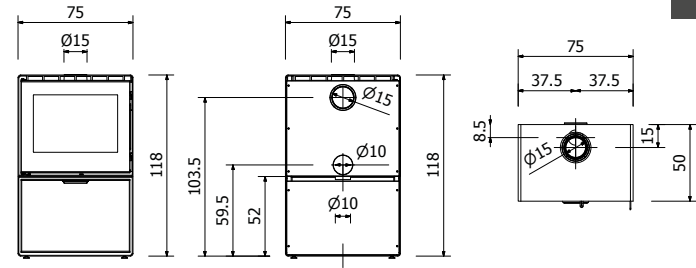

La forma lineare ed armoniosa di questa stufa a legna fa godere pienamente della magia del fuoco che danza al suo interno. Il grande focolare facilita l'inserimento di ciocchi di legna di generose dimensioni per una lunga durata del fuoco e dona tanto piacevole calore. Nella parte inferiore, un grande cassettono permette di stoccare molta legna.

The linear and harmonious shape of this woodstove makes you fully enjoy the magic of the fire dancing inside it. Its large firebox facilitates the loading of generous sized logs for a long duration of the fire, giving you an especially pleasant warmth. In its lower part, a large drawer allows to store big quantities of wood.

La forme linéaire et harmonieuse de ce poêle à bois consent de jouir pleinement de la magie du feu qui danse à l'intérieur. Le grand foyer facilite l'insertion des bûches de bois de taille généreuse pour une longue durée du feu, en donnant une chaleur agréable à votre maison. Au fond, un grand tiroir vous permet de stocker beaucoup de bois.

Die geradlinige und harmonische Form dieses Holzofens lässt Sie den Zauber des Feuers der im Inneren lodert genießen. Der große Feuerraum erleichtert das Auflegen von großen Holzscheiten und sorgt für eine langanhaltende und wohlige Wärme. Die unten angebrachte Schublade bietet ausreichend Platz um Brennholz zu stapeln.

🔥 SC 75											
📊 Kg	250 kg										
⚡ kW	10,9 kW										
m ³	230 ÷ 375 m ³										
🔧	Ø 15 cm										
↕	12 Pa										
η	80,9 %										
CO	946 mg/mc										
EP	13,5 mg/mc										
🔥	ceramica refrattaria refractory ceramics céramique réfractaire Hitzebeständige Keramik										
📏	31 cm 57 cm 30 cm										
📦	3 kg/h – cm 33/50										
OPTIONAL	<table border="1"> <tr> <td>VF</td> <td>CP</td> <td>🔧</td> <td></td> <td></td> </tr> <tr> <td>×</td> <td>×</td> <td>✓</td> <td></td> <td></td> </tr> </table>	VF	CP	🔧			×	×	✓		
VF	CP	🔧									
×	×	✓									

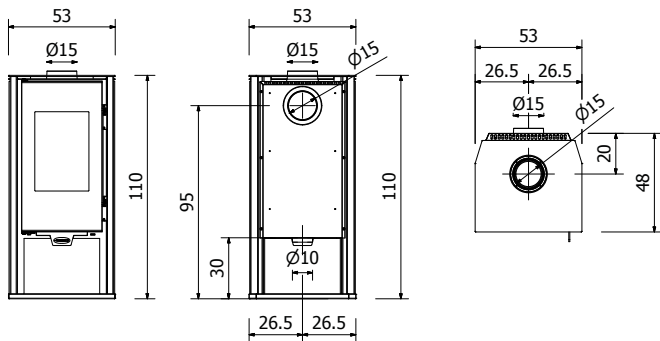









Una stufa a legna performante che grazie al suo design equilibrato, non è soggetta alla moda passeggera. Con il suo stile e le molte varianti del rivestimento in maiolica o pietra, si inserisce perfettamente in qualsiasi ambiente.

A high performance wood stove which, thanks to its balanced design, is not subject to fad influence. With its style and many variants of tiled or stone finish, it fits perfectly in any environment.

Un poêle à bois performant qui, grâce à son design équilibré, n'est pas soumis à la mode passagère. Avec son style et les nombreuses variantes du revêtement en faïence ou en pierre, ce poêle s'intègre parfaitement dans tout environnement.

Ein funktionstüchtiger Holzofen, der Dank seines ausgewogenen Designs nie aus der Mode kommt. Mit seinen vielen Ausführungsvarianten und verschiedenen Verkleidungen aus Majolika oder Stein fügt er sich perfekt in jeden Raum ein.

 S 80				
 160 kg				
 9,2 kW				
 180 ÷ 320 m ³				
 $\varnothing 15$ cm				
 11 Pa				
 84 %				
CO 955 mg/mc				
EP 12,4 mg/mc				
 ceramica refrattaria refractory ceramics céramique réfractaire Hitzebeständige Keramik	 36 cm 33 cm 32 cm			
 M PS				
 2,5 kg/h – cm 25				
OPTIONAL				
 VF	 CP			
				



S 80





CRETA

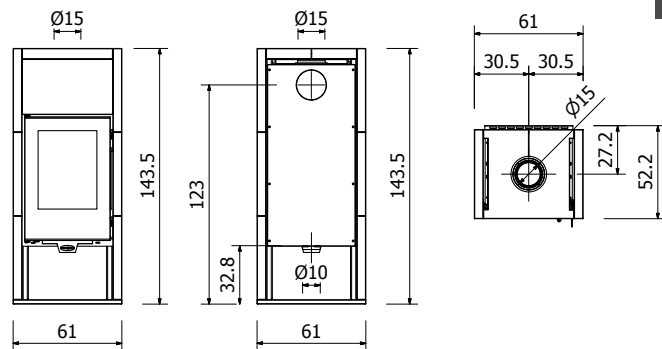

Stufa a legna di grande potenza e dall'estetica intramontabile. La sua importante massa di pietra naturale permette di avere una straordinaria emissione di calore confortevole anche dopo molte ore che si è spento il fuoco. Disponibile a richiesta la versione con accumulo interno plus.

Extremely powerful woodstove with a timeless aesthetics. Its considerable natural stone mass allows for an extraordinary, comfortable heat emission that lasts even many hours after the fire has burned out. Available on request even the version with "internal heat accumulation plus".

Un poêle à bois à grande puissance et à l'esthétique intemporelle. Sa masse considérable en pierre naturelle consent d'obtenir une émission extraordinaire de confortable chaleur même après plusieurs heures que le feu s'est éteint. Disponible, sur demande, la version avec accumulation interne plus.

Ein zeitloser, leistungsstarker Holzofen. Seine massive Natursteinverkleidung garantiert eine einzigartige Wärmeausstrahlung, auch stundenlange nach Ausschalten des Ofens. Auf Anfrage ist die Version mit interner Wärmespeicherung plus erhältlich.

🔥 SP 300					
📊 kg	408 kg / 488 kg Plus				
⚡ kW	9,2 kW				
m ³	180 ÷ 320 m ³				
🔥	Ø 15 cm				
⬇️⬆️⬆️⬆️	12 Pa				
η	84 %				
CO	955 mg/mc				
EP	12,4 mg/mc				
🔥	ceramica refrattaria refractory ceramics céramique réfractaire Hitzebeständige Keramik				
📏	35 cm 38 cm 35 cm				
📏	PS				
👉	3,4 kg/h – cm 33				
OPTIONAL	VF	CP	👉		
	✗	✗	✓		

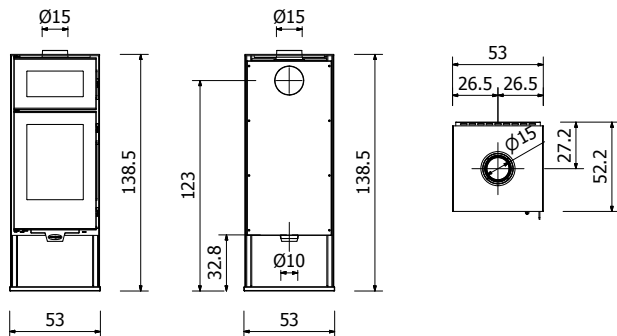























Stufa a legna dal design puro ed elegante che si inserisce perfettamente in qualsiasi tipo di ambientazione. Mentre nel grande focolare inferiore la legna arde con grazia, nel vano superiore i vostri cibi diventano sfiziosi e saporiti. La vostra casa durante tutto l'inverno diventerà calda e confortevole.

With its pure and elegant design, this woodstove fits perfectly into any kind of environment. While in the lower large fireplace logs are gracefully burning, in the top compartment your foods become tasty and flavorful. Your home will be warm and cozy all winter through.

Poêle à bois avec un design pur et élégant qui s'intègre parfaitement dans tout environnement. Tandis que dans le grand foyer inférieur le bois est en train de brûler gracieusement, dans le compartiment supérieur vos aliments deviennent délicieux et savoureux. Votre maison pendant tout l'hiver sera donc chaude et confortable.

Dieser Holzofen in reinem und elegantem Design eignet sich für jede Einrichtung. Während im großen Feuerraum das Feuer anmutig lodert und knistert, können Sie gleichzeitig im Backfach schmackhafte Speisen garen. Ihr Zuhause wird während des ganzen Winters warm und behaglich sein.

 SF 100											
	247 kg										
	9,2 kW										
	180 ÷ 320 m³										
	Ø 15 cm										
	12 Pa										
	84 %										
	955 mg/mc										
	12,4 mg/mc										
	ceramica refrattaria refractory ceramics céramique réfractaire Hitzebeständige Keramik										
	18 cm 38 cm ↙ 33 cm										
											
	3,4 kg/h – cm 33										
OPTIONAL	<table border="1"> <tr> <td></td> <td></td> <td></td> <td></td> <td></td> </tr> <tr> <td>×</td> <td>×</td> <td>✓</td> <td></td> <td></td> </tr> </table>						×	×	✓		
											
×	×	✓									



CRETA MAXI METAL





CRETA MAXI PIETRA

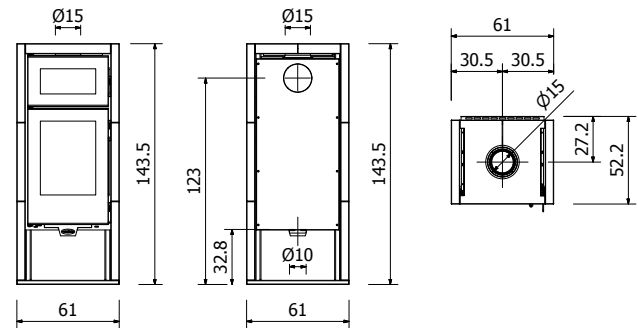



Splendida stufa a legna con vano scaldavivande. Mentre nel focolare inferiore danzano le fiamme, nel vano superiore cuociono pietanze dal sapore unico. L'importante rivestimento in pietra naturale, permette un accumulo di calore che rende estremamente confortevole la vostra amata casa.

Gorgeous woodstove with food warmer compartment. While in the lower firebox the flames are dancing, in the upper compartment dishes of unique flavor are being cooked. The important natural stone cladding allows for an accumulation of heat, making your beloved home extremely comfortable.

Un poêle à bois superbe avec boîte réchaud pour aliments. Tandis que dans le foyer inférieur les flammes dansent, dans la boîte supérieure des plats au saveur unique sont en train de mijoter. Le riche revêtement en pierre naturelle consent une accumulation de chaleur qui rendra extrêmement confortable votre maison bien-aimée.

Wunderschöner Holzofen mit Backfach. Während unten im Feuerraum die Flammen tanzen, garen oben im Backfach leckere Speisen. Die massive Verkleidung aus Naturstein sorgt für eine Wärmespeicherung die das geliebte Zuhause äußerst gemütlich macht.

 SF 200					
 Kg	408 kg				
 kW	9,2 kW				
m³	180 ÷ 320 m ³				
 Ø	Ø 15 cm				
 ↓ ↑	12 Pa				
η	84 %				
CO	955 mg/mc				
EP	12,4 mg/mc				
	ceramica refrattaria refractory ceramics céramique réfractaire Hitzebeständige Keramik				
	18 cm 38 cm ↙ 33 cm				
	PS				
	3,4 kg/h – cm 33				
OPTIONAL	VF	CP			
	×	×	✓		



FIAMMETTA

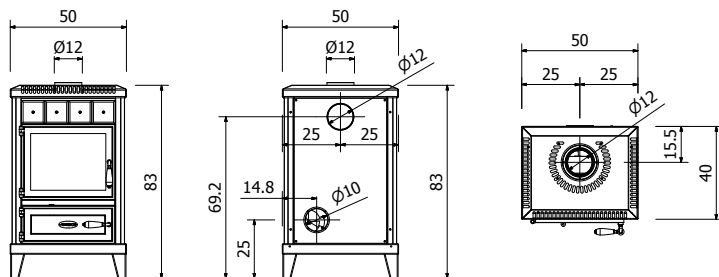













La stufa Fiammetta nonostante le sue dimensioni contenute, vi regalerà tanto piacevole calore nelle più fredde giornate invernali o nelle umide serate autunnali. Disponibile con vari tipi di rivestimento che la rende adatta a molte tipologie di ambientazione.

Despite its small size, Fiammetta will give you plenty of warmth on the coldest winter days or in the rainy autumn evenings. Available with various types of cladding making it suitable for many different settings.

Le poêle Fiammetta, malgré ses dimensions compactes, vous donnera tant de chaleur et de confort pendant les jours froids d'hiver ou les soirées humides d'automne. Disponible avec différents types de revêtement qui le rendent indiqué à nombreux styles d'ameublement.

Der Ofen Fiammetta schenkt Ihnen trotz seiner zurückhaltenden Größe viel angenehme Wärme an kalten Wintertagen oder feuchten Herbstabenden. Er ist mit verschiedenen Verkleidungen erhältlich und passt sich somit perfekt an die unterschiedlichen Einrichtungsstile an.

SCP 003

 kg	126 kg				
 kW	10,8 kW				
 m ³	200 ÷ 325 m ³				
	12 Ø cm				
	12 Pa				
 η	80,6 %				
 CO	477 mg/mc				
 EP	40 mg/mc				
	ghisa cast iron / fonte / guss				
	31 cm \times 33 cm \times 25 cm				
	M PB 10x10				
	3 kg/h – cm 25				
OPTIONAL	VF	CP			
	×	×	✓		



ESMERALDA

C/CORRIMANI

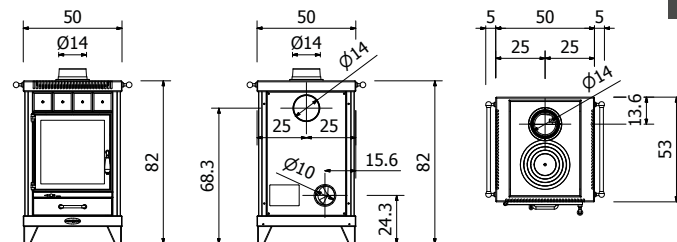















L'Esmeralda si caratterizza per la grande porta vetrata che permette una perfetta visione delle fiamme scoppiettanti e dalla piastra superiore con cerchi, pronta a cucinare le vostre pietanze preferite. Perfetta anche per le case vacanza di montagna, ecc.

Esmeralda is characterized by a large glass door allowing a perfect view of the crackling flames and by an upper plate with circles, perfect for cooking your favorite dishes. Most suitable also for a mountain vacation home, etc....

Esmeralda se caractérise par la grande porte vitrée qui permet une vision parfaite du feu crépitant et par la plaque supérieure avec des cercles, prête à cuire vos plats préférés. Ce poêle est parfait même pour des maisons pour les vacances à la montagne, etc.

Esmeralda sticht durch seine beachtenswert große Glastür hervor, die eine wunderbare Sicht auf das Flammenbild bietet. Das Zubereiten Ihrer Lieblings Speisen auf der massiven Herdplatte mit Mehringdeckel wird zum Vergnügen. Er eignet sich perfekt für Ferienwohnungen in den Bergen, usw.

S 036

 kg	146 kg		
 kW	10,8 kW		
 m ³	200 ÷ 325 m ³		
 cm	14 Ø cm		
	12 Pa		
 η	80,6 %		
 CO	477 mg/mc		
 EP	40 mg/mc		
	ghisa cast iron / fonte / guss 33 cm 31 cm ↘ 35 cm		
	M PB  10x10		
	3 kg/h – cm 25		
OPTIONAL	VF + CP 		
			



ESMERALDA MAXI

C/CORRIMANI

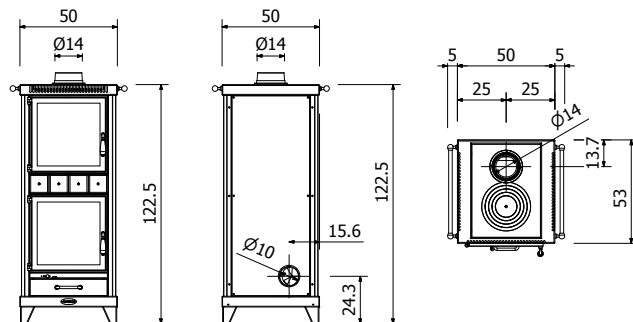













Stufa a legna compatta ma dalle generose prestazioni. Grande focolare con ampia porta vetrata, capiente vano di cottura sempre pronto a sfornare deliziose pietanze e top superiore con cerchi che vi consentirà di tenere in caldo tanti gustosi manicaretti.

Compact wood stove yet with high performances. Wide firebox with big glass door, large cooking compartment always ready to cook delicious dishes and upper plate with circles allowing you to keep warm all your tasty delicacies.

Poêle à bois compact, mais aux performances extraordinaires. Grand foyer avec large porte vitrée, compartiment cuisson à grande capacité toujours prêt à défourner des plats délicieux ainsi que plaque supérieure avec cercles qui vous permettra de garder bien chauds beaucoup de plats savoureux.

Massiver Holzofen mit ausgiebiger Leistung. Geräumiger Feuerraum mit großer Glastür, Backfach zum Kochen und Backen köstlicher Gerichte sowie Kochplatte mit Mehrringdeckel zum Warmhalten oder Aufwärmen der Leckerbissen.

 S 037				
 kg	181 kg			
 kW	10,8 kW			
m³	200 ÷ 325 m ³			
 cm	14 0 cm			
 Pa	12 Pa			
η	80,6 %			
CO	477 mg/mc			
EP	40 mg/mc			
 ghisa cast iron / fonte / guss	33 cm 31 cm ↘ 35 cm			
 cm	35 cm 28 cm ↘ 40 cm			
 M PB  10x10				
 kg/h – cm 25				
OPTIONAL	VF + CP 	<input checked="" type="checkbox"/>	<input type="checkbox"/>	<input type="checkbox"/>
		<input type="checkbox"/>	<input checked="" type="checkbox"/>	<input type="checkbox"/>



PARISIEN

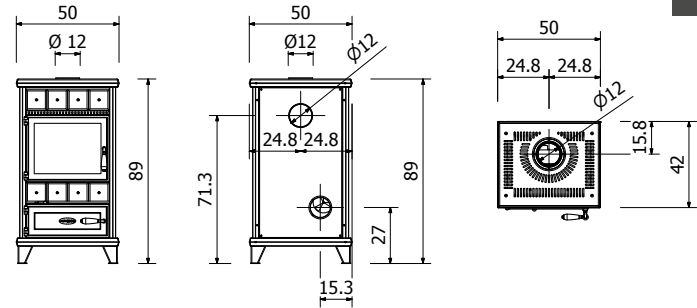













La Parisien è una delle stufe "storiche" della gamma Wekos e una delle più vendute. Le dimensioni contenute la rendono adatta a qualsiasi ambientazione e le molte varianti dei rivestimenti disponibili soddisfano anche i più esigenti.

Parisien is one of the "historic" stoves in the Wekos range and one of the most sold. Its small size makes it suitable for any environment and its numerous available finishes and cladding options will satisfy even the most demanding customers.

Parisien est l'un des poêles « historiques » de la gamme Wekos et l'un des plus vendus. Sa taille petite le rend indiqué à tout ambiance et les nombreuses variantes de revêtements disponibles satisfont même les clients les plus exigeants.

Einer der „historischen“ und meistverkauften Öfen der Wekos Produkte. Mit seinen zurückhaltenden Ausmaßen ist er für jede beliebige Wohnausstattung geeignet und die vielen zur Verfügung stehenden Verkleidungsvarianten erfüllen auch die anspruchsvollsten Wünsche.

SCP 004

	139 kg				
	10,8 kW				
	200 ÷ 325 m ³				
	12 Ø cm				
	12 Pa				
	80,6 %				
	477 mg/mc				
	40 mg/mc				
	ghisa cast iron / fonte / guss				
	31 cm x 33 cm x 25 cm				
	M PB 10x10				
	3 kg/h – cm 25				
OPTIONAL	VF	CP			
	✓	✓	✓		



AVVENTURINA

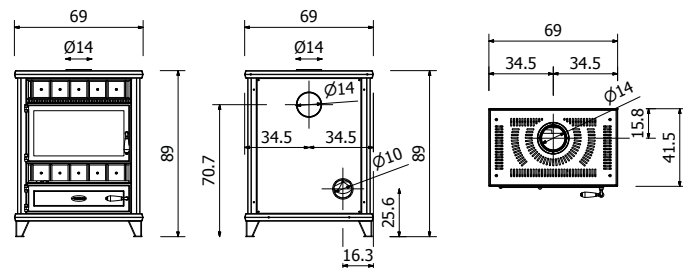

Questa stufa grazie alla ridotta profondità può essere posizionata in tutte quelle situazioni dove lo spazio è ridotto. Il largo focolare permette l'utilizzo di ceppi di legna lunghi fino a 50 cm e il grande vetro vi farà ammirare il fuoco scoppiettante.

Thanks to its reduced depth, this large woodstove is ideal for space-constraint rooms. Its large firebox allows the use of logs up to 50 cm long while its big glass will show you the crackling fire.

Ce poêle, grâce à sa profondeur réduite, peut être positionné dans tous les aménagements où l'espace est réduit. Le large foyer permet l'utilisation de bûches jusqu'à 50 cm et la grande porte vitrée vous consentira d'admirer le feu crépitant.

Dank seiner reduzierten Tiefe kann er auch dort positioniert werden, wo nicht so viel Platz zur Verfügung steht. In den breiten Feuerraum können bis zu 50 cm lange Holzstücke aufgelegt werden und durch die große Sichtscheibe können Sie den Blick auf das lodernde Feuer genießen.

🔥 S 039	
📊 kg	147 kg
⚡ kW	14 kW
m ³	260 ÷ 420 m ³
🔥 cm	14 Ø cm
⬇️⬆️	12 Pa
η	80,1 %
CO	1135 mg/mc
EP	39 mg/mc
🔥	ghisa cast iron / fonte / guss
📏	31 cm 51 cm / 26 cm
📏	M PB 10x10
👉	4 kg/h – cm 33/50
OPTIONAL	VF CP
	✓ ✓ ✓



AVVENTURINA

C/PIASTRA E CORRIMANI

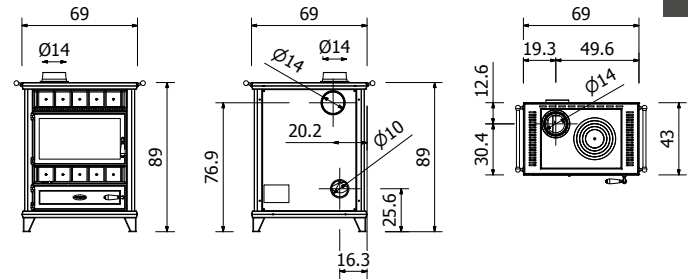

Stufa dall'aspetto classico ma che si integra perfettamente in qualsiasi tipo di arredamento grazie alla possibilità di scegliere varie tipologie di rivestimento. La sua peculiarità è la piastra di cottura presente sul top che consente di cucinare gustose pietanze.

Classic-style stove yet perfectly integrating into any kind of furnishing thanks to the wide choice of different types of finishing. Its distinctiveness is the upper cooking plate allowing to cook tasty dishes.

Poêle à l'aspect classique mais qui s'intègre parfaitement dans tout type d'intérieur, grâce à la possibilité de choisir de différents types de revêtement. Sa particularité est la plaque de cuisson sur la partie supérieure qui vous permet de cuire des aliments savoureux.

Dank der vielen verschiedenen Verkleidungsvarianten passt sich dieser klassisch gestaltete Ofen jedem Einrichtungsstil an. Auf der Kochplatte können Sie leckere Speisen zubereiten.

🔥 S 040									
🏋️ Kg	154 kg								
⚡ kW	14 kW								
m ³	260 ÷ 420 m								
🔧	14 Ø cm								
📏	12 Pa								
η	80,1 %								
CO	1135 mg/mc								
EP	39 mg/mc								
🔥	ghisa cast iron / fonte / guss 31 cm 51 cm ↙ 26 cm								
🏠	M PB 10x10								
🔥	4 kg/h – cm 33/50								
OPTIONAL	<table border="1"> <tr> <td>VF + CP</td> <td>🔧</td> <td>DX</td> <td></td> </tr> <tr> <td>✓</td> <td>✓</td> <td>✓</td> <td></td> </tr> </table>	VF + CP	🔧	DX		✓	✓	✓	
VF + CP	🔧	DX							
✓	✓	✓							



AVVENTURINA MAXI

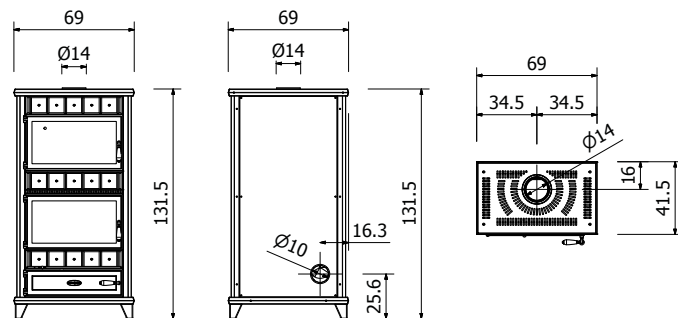

Stufa a legna larga e poco profonda, adatta ad essere inserita in ambienti dove lo spazio è ridotto. Il largo focolare accoglie ceppi fino a 50 cm mentre il vano superiore è sempre pronto a sfornare pietanze sfiziose e cotte a puntino.

Large and shallow wood stove, suitable for environments where space is limited. Its large firebox accommodates logs up to 50 cm while its upper plate is always ready to prepare delicious and perfectly cooked dishes.

Poêle à bois large et peu profond, indiqué pour être inséré dans les aménagements où l'espace est réduit. Le large foyer accueille des bûches jusqu'à 50 cm tandis que le compartiment supérieur est toujours prêt à cuire à la perfection des plats délicieux.

Der breite aber wenig tiefe Ofen passt auch dort hin, wo wenig Platz vorhanden ist. In den breiten Feuerraum können bis zu 50 cm lange Holzscheite aufgelegt werden und gleichzeitig können Sie im Backfach schmackhafte Gerichte zubereiten.

🔥 S 041	
📊 kg	191 kg
⚡ kW	14 kW
m ³	260 ÷ 420 m ³
🔥 14 0 cm	-
⬇️⬆️ 12 Pa	-
η	80,1 %
CO	1135 mg/mc
EP	39 mg/mc
🔥	ghisa cast iron / fonte / guss
🍲	27 cm 42 cm ↘ 28 cm
📏	M PB 10x10
👉	4 kg/h – cm 33/50
OPTIONAL	VF CP
	✓ ✓ ✗



VENETIEN

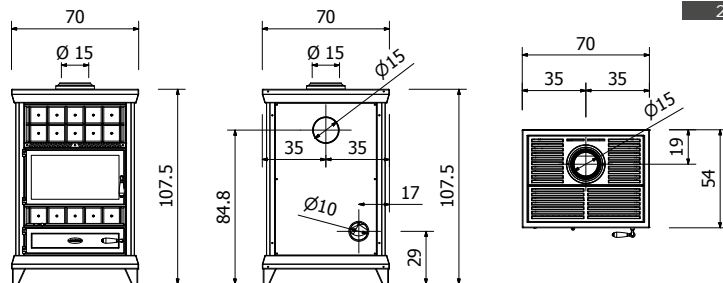













La stufa Venetien conserva un design tradizionale ma, grazie alle sue forme equilibrate e alle molteplici varietà dei rivestimenti proposti, si integra perfettamente in qualsiasi tipo di ambientazione. Offre prestazioni caloriche elevate mentre la grande porta vetrata dona una piacevole visione delle fiamme danzanti.

The Venetien woodstove retains a traditional design but, thanks to its balanced forms and its multiple varieties of proposed claddings, it perfectly matches with any type of setting. It ensures a high calorific performance while its large glass door gives a nice view of the dancing flames.

Le poêle Venetien conserve un design traditionnel mais, grâce à ses formes équilibrées et aux multiples variétés de finitions disponibles, s'intègre parfaitement dans tous les décors d'intérieurs. Le poêle offre une haute performance calorique tandis que la grande porte vitrée donne une vue agréable sur les flammes dansantes.

Der Ofen Venetien bewahrt ein traditionelles Design und Dank seiner ausgeglichenen Formen und der vielen zur Verfügung stehenden Verkleidungsvarianten passt er sich jedem Einrichtungsstil an. Er hat eine hohe Heizleistung und durch die große Glastür bietet er einen unvergesslichen Blick auf das Flammenbild.

SM 003

	265 kg				
	14 kW				
	260 ÷ 420 m ³				
	15 Ø cm				
	12 Pa				
	76,4 %				
	815 mg/mc				
	31 mg/mc				
	ghisa cast iron / fonte / guss				
	33 cm 50 cm 35 cm				
	M PB 10x10				
	4,3 kg/h – cm 33/50				
OPTIONAL	VF	CP			
	✓	✓	✓		



TERMO VENETIEN

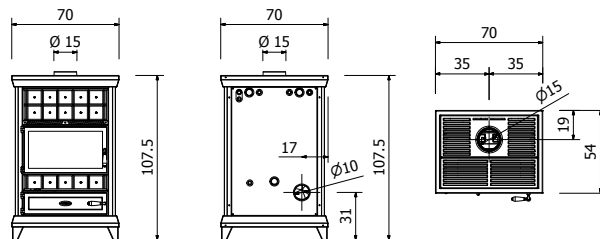

Con il suo design classico non soggetto alle mode, e con le molte varianti di rivestimento esterno, questa termo stufa troverà estimatori anche nelle persone più esigenti. L'ampio focolare vetrato e la potente caldaia non potranno che suscitare tanta passione per il fuoco, durante tutto il periodo freddo.

With its classic design that is not subject to fashion, and its multiple finishes and claddings, this thermo-woodstove will be appreciated even by the most demanding customers. Its large firebox with a glass door as well as its powerful boiler will make you love its fire throughout the cold period.

Avec son design classique non soumis aux tendances passagères ainsi que ses nombreuses variantes de revêtement extérieur, ce poêle trouvera des admirateurs même parmi les clients les plus exigeants. Le large foyer vitré et la chaudière puissante vous feront aimer le feu, pendant toute la période froide.

Sein klassisches Design kommt nie aus der Mode und mit den vielen Verkleidungsvarianten findet er auch unter anspruchsvollsten Kunden neue Bewunderer. Der großräumige Feuerraum und der leistungsstarke Heizkessel erwecken während der kalten Wintertage die Leidenschaften für das Feuer.

STCP 010

	250 kg			
	18,3 kW			
	380 ÷ 620 m ³			
	12,6 kW			
	5,7 kW			
	15 Ø cm			
	12 Pa			
	2 bar			
	81,8 %			
	1125 mg/mc			
	50,2 mg/mc			
	30/10 sp. / thk. / ep. / D.	52 Lt	VAC	
	ghisa cast iron / fonte / guss	33 cm 48 cm	32 cm	
	M PB	10x10		
	5,3 kg/h - cm 33			
OPTIONAL	VF	CP		
	×	×	×	



VENETIEN MAXI

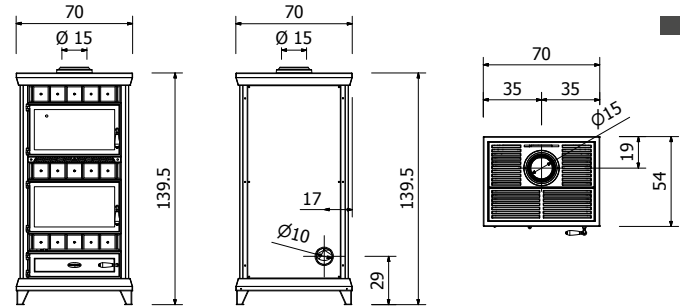















Linea classica, solida e molto potente. Questa grande stufa a legna è in grado di donarvi tanto calore e tante pietanze gustose perfettamente cotte nel grande vano superiore. Il grande focolare permette l'utilizzo di ceppi fino a 50 cm.

Classic line, solid and very powerful. This large woodstove will give you so much heat and plenty of tasty dishes perfectly cooked in its wide upper compartment. Its large firebox allows the use of logs up to 50 cm.

Ligne classique, solide et très puissante. Ce grand poêle à bois pourra vous donner tant de chaleur ainsi que beaucoup de plats délicieux parfaitement cuits dans son grand compartiment supérieur. Le grand foyer permet l'utilisation de bûches jusqu'à 50 cm.

Eine klassische, strapazierfähige und leistungsstarke Linie. Dieser große Holzofen schenkt viel wohlige Wärme und perfekt gegarte Speisen die im Backfach brutzeln. In den großen Feuerraum passen Holzscheite von bis zu 50 cm Länge.

SM 004

	290 kg			
	14 kW			
	260 ÷ 420 m³			
	15 Ø cm			
	12 Pa			
	76,4 %			
CO	815 mg/mc			
EP	31 mg/mc			
	ghisa cast iron / fonte / guss			
	27 cm 42 cm ↓ 40 cm			
	M PB  10x10			
	4,3 kg/h – cm 33/50			
OPTIONAL	VF			
	CP			



VALMALENCO

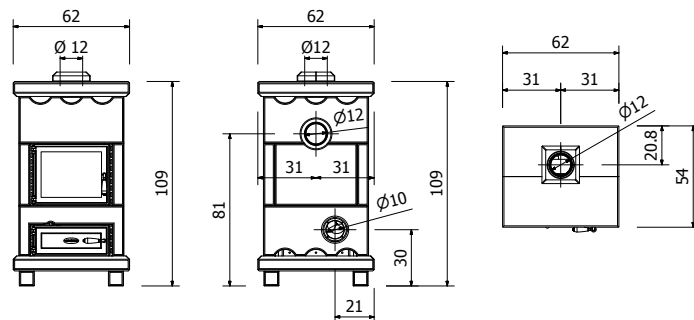













Questa stufa a legna è una versione media della collezione Wekos in pietra serpentino d'accumulo. L'importante massa di pietra e il robusto focolare sono garanzia di tanti anni di sano e gradevole calore che allieterà anche i più freddi inverni.

This woodstove is a medium version of the Wekos collection of serpentine stone accumulation models. Its important mass of stone and a sturdy firebox are a guarantee of many years of healthy and comfortable warmth that will brighten up even the coldest winters.

Ce poêle à bois est une version moyenne parmi la collection Wekos de pierre serpentine d'accumulation. Sa masse considérable en pierre et son solide foyer représentent une garantie de plusieurs années de chaleur saine et confortable qui remplira de bonheur votre maison même pendant les hivers les plus froids.

Dieser Holzofen aus wärmespeicherndem Serpentinstein ist der goldene Mittelweg der Wekos Öfen. Die beachtliche Steinmasse und der robuste Feuerraum garantieren auch in den noch so kalten Wintern viele Jahre wohlige Wärme.

SCP 013

	465 kg				
	10,8 kW				
	200 ÷ 325 m³				
	12 Ø cm				
	12 Pa				
	80,6 %				
	477 mg/mc				
	40 mg/mc				
	ghisa cast iron / fonte / guss				
	31 cm  25 cm				
	3 kg/h – cm 25				
OPTIONAL	VF	CP			
	×	×	✓		



AURINA

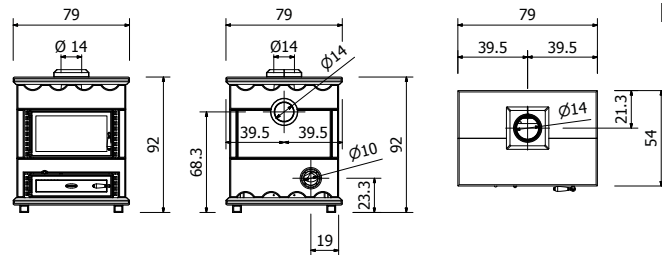













La stufa a legna Aurina, con il suo massiccio rivestimento in pietra serpentino e con decori a scelta, vi donerà tanto e confortevole calore anche nelle più fredde giornate invernali. Il capiente focolare permette di inserire ceppi di legna anche di 50 cm per garantire tante ore di fuoco.

The Aurina woodstove, with its massive cladding of serpentine stone and its various possible finishes, will give you so much comfort and warmth even on the coldest winter days. Its large firebox will allow you to load logs of up to 50 cm to ensure plenty of hours of fire.

Le poêle à bois Aurina, avec son solide revêtement en pierre serpentine et ses finitions au choix, vous donnera tant de chaleur confortable même dans les jours les plus froids d'hiver. Son foyer spacieux consent le chargement de bûches jusqu'à 50 cm assurant de nombreuses heures de feu.

Der Holzofen Aurina mit seiner massiven Serpentinsteinerkleidung und mit individuellem Dekor schenkt behagliche Stunden an kalten Wintertagen. Der großzügige Feuerraum nimmt auch große Holzscheite von 50 cm auf und garantiert ein anhaltendes Feuer.

SCP 023

	468 kg				
	14 kW				
	260 ÷ 420 m ³				
	14 Ø cm				
	12 Pa				
	80,1 %				
	1135 mg/mc				
	39 mg/mc				
	ghisa cast iron / forte / guss				
	PB				
	4 kg/h – cm 33/50				
OPTIONAL	VF	CP			
	×	×	✓		



VALTELLINA

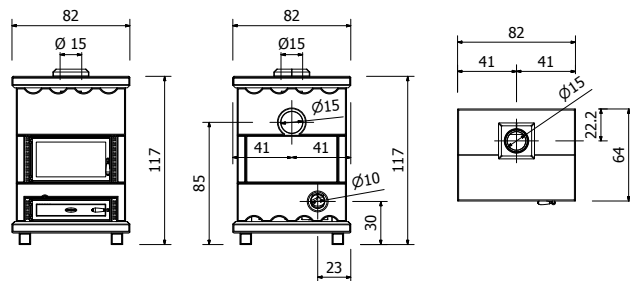











Magnifica e potente stufa a legna. Il rivestimento massiccio in pietra serpentino bocciardato e il decoro realizzato da mani esperte, ne fanno opere d'arte "su misura" per clienti che apprezzano prodotti senza tempo. Il grande focolare può contenere ceppi fino a 50 cm. La grande massa di accumulo garantisce un sano e piacevole calore per oltre 10/12 ore.

A gorgeous and powerful woodstove. Its massive hammered serpentine cladding and its decor made by skilled hands make it a "tailor-made" artwork for customers appreciating timeless products. Its large firebox can contain logs up to 50 cm. Its great accumulation mass guarantees a healthy and pleasant warmth for over 10/12 hours.

Poêle à bois magnifique et puissant. Le revêtement en pierre serpentine massive bouchardée et la finition réalisée par des mains expertes en font une œuvre d'art sur mesure pour des clients qui apprécient les produits intemporels. Son grand foyer peut contenir des bûches jusqu'à 50 cm. La grande masse d'accumulation assure une chaleur saine et agréable pendant plus de 10/12 heures.

Wunderschöner und leistungsstarker Holzofen. Die massive, aufgeraute Serpentinsteinerkleidung und das von erfahrenen Händen realisierte Dekor machen diesen Ofen zu einem maßgefertigten Kunstwerk für Kunden die zeitlose Erzeugnisse schätzen. Der große Feuerraum kann Holzscheite von bis zu 50 cm aufnehmen und schenkt für 10 bis 12 Stunden eine gesunde und wohlige Wärme.

SCP 014

	725 kg				
	14 kW				
	260 ÷ 420 m ³				
	15 Ø cm				
	12 Pa				
	76,4 %				
CO	815 mg/mc				
EP	31 mg/mc				
	ghisa cast iron / fonte / guss				
	33 cm 50 cm 35 cm				
	PB				
	4,3 kg/h - cm 33/50				
OPTIONAL	VF	CP			
	×	×	✓		

PORTALEGNA

LOG STACKERS / PORTE-BÛCHES / HOLZABLAGEN



PL 2-P8

NERO
BLACK
NOIR
SCHWARZ



PL 3-P8

NERO
BLACK
NOIR
SCHWARZ

N.B.: I PORTALEGNA PL2 E PL3 SONO DISPONIBILI NEI COLORI GRIGIO E NERO
N.B.: PL2 E PL3 LOG STACKERS ARE AVAILABLE IN GREY OR BLACK COLOUR
NB: LE SUPPORT DE BOIS PL2 ET PL3 SONT DISPONIBLES EN GRIS ET NOIR
NB: DIE HOLZABLAGEN PL2 UND PL3 SIND IN GRAU UND SCHWARZ LIEFERBAR

PIASTRE

FIREPROOF PAD / PLAQUES / PLATTEN



PIASTRA NERA D'APPOGGIO
BLACK FIREPROOF PAD
PLAQUE NOIR APPUI
SCHWARZE ABSTELLPLATTE

MANIGLIE

HANDLES / POIGNÉES / GRIFFE



MANIGLIA IN OTTONE
PORCELLANA NERA

BRASS AND BLACK
PORCELAIN HANDLE

POIGNÉE LAITON
PORCELAINE NOIRE

GRIFF AUS MESSING /
PORZELLAN SCHWARZ



MANIGLIA INOX
PORCELLANA AVORIO

STAINLESS STEEL AND
IVORY PORCELAIN
HANDLE

POIGNÉE LAITON
PORCELAINE IVOIRE

GRIFF AUS EDELSTAHL /
PORZELLAN ELFENBEIN



MANIGLIA INOX
PORCELLANA BIANCA

STAINLESS STEEL AND
WHITE PORCELAIN
HANDLE

POIGNÉE LAITON
PORCELAINE BLANCHE

GRIFF AUS EDELSTAHL /
PORZELLAN WEISS

ACCESSORI

ACCESSORIES / ACCESSOIRES / ZUBEHÖR



PIASTRELLE 10 X 10 PER STUFE

10 X 10 TILES FOR STOVES / 10 X 10 CARREAUX POUR PÔELES / 10 X 10 KACHELN FÜR ÖFEN

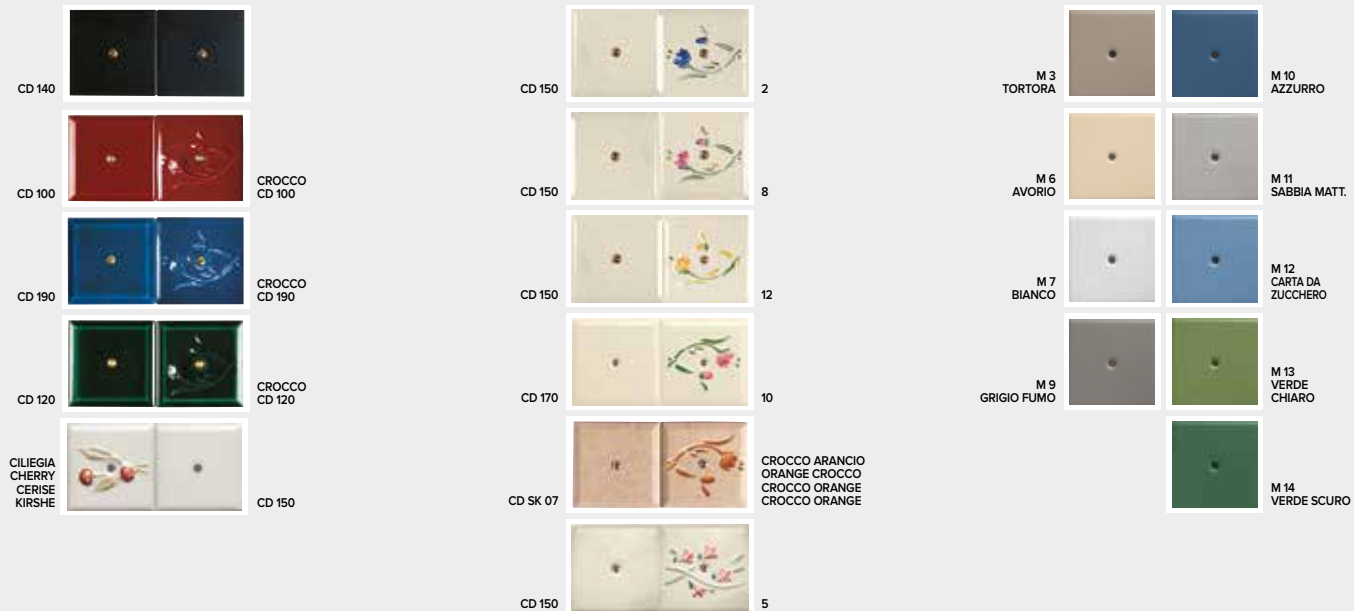

RIVESTIMENTI COVERINGS / REVÊTEMENTS / VERKLEIDUNGEN

M MAIOLICA STUFE

MAJOLICA / MAJOLIQUE / MAJOLIKA



BIANCO OPACO
WHITE
BLANC
MATT WEISS



BEIGE LUCIDO
GLOSSY BEIGE
BEIGE CLAIR
BIGE POLIERT



NOCCIOLA
HAZEL
NOISETTE
HASELNUSS



BORDEAUX



TORTORA
DOVE GREY
TOURTERELLE
TURTELTAUBE



NERO OPACO
MATTE BLACK
NOIR OPAQUE
MATT SCHWARZ

PB DECORI PER STUFE IN PIETRA BOCCIARDATA

TRIM FOR STOVES IN BUSH-HAMMERED STONE / DÉCORS POUR POÊLES EN PIERRE BOUCHARDÉE /
STEINDEKOR FÜR ÖFEN

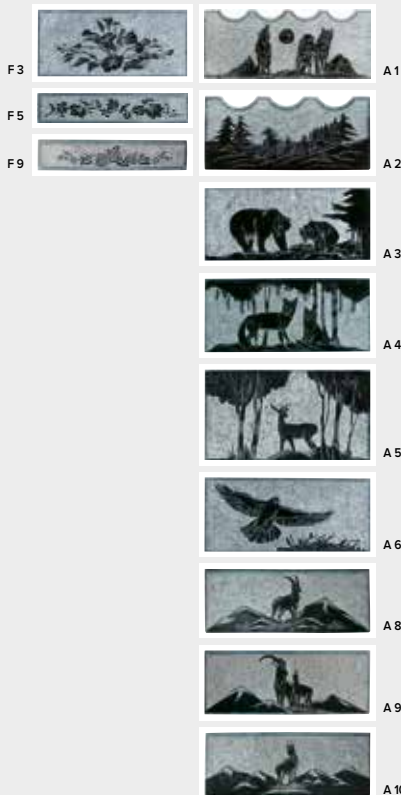

DECORI PER "AURINA"
TRIM FOR "AURINA"
DÉCORS POUR "AURINA"
DEKOR FÜR „AURINA“



A 11



A12

La pietra serpentino utilizzata da Wecos per rivestire le proprie stufe è una pietra naturale grigia con sfumature di colore verde che viene estratta e lavorata in Valmalenco provincia di Sondrio – Italia. Questa pietra ha la capacità di accumulare calore che rilascia poi lentamente anche a stufa spenta creando un ambiente confortevole e sano.

The serpentine used by Wecos for facing its stoves is a natural grey stone with green undertones. It is extracted and processed in Valmalenco located in the Province of Sondrio – Italy. This stone has the ability to absorb heat and radiate it slowly even with the stove off, thus creating a comfortable and healthy environment.

La pierre serpentine utilisée par Wecos pour le revêtement de ses poêles est une pierre naturelle grise avec des nuances vertes. Cette pierre est extraite et taillée à Valmalenco, dans la province de Sondrio (Italie du Nord). Cette pierre a la possibilité d'accumuler la chaleur qui rayonne lentement par la suite, même lorsque le poêle est éteint, créant ainsi une atmosphère confortable et saine.

Der für die Verkleidung der Wecos Öfen eingesetzte Serpentinsteinst ist ein grauer Naturstein mit grünlicher Farbschattierung der in Valmalenco / Provinz Sondrio - Italien abgebaut und bearbeitet wird. Dieser Stein hat die Kapazität Wärme zu speichern und diese auch bei ausgeschaltetem Ofen langsam abzugeben und garantiert somit eine langanhaltende Wärmeversorgung in einer behaglichen und gesunden Atmosphäre.













SCHEMA TIPO PER ALLACCIAMENTO CALDAIA A TERMOSTUFA A LEGNA CON IMPIANTO DI RISCALDAMENTO A VASO CHIUSO

STANDARD DIAGRAM FOR BOILER CONNECTION TO THERMO STOVE WITH SEALED HEATING SYSTEM

SCHEMA DE PRINCIPE DU RACCORDEMENT DE LA CHAUDIÈRE SUR UNE POÊLE À BOIS AVEC INSTALLATION DE CHAUFFAGE À VASE D'EXPANSION FERMÉ

PLANBEISPIEL FÜR DEN ANSCHLUSS DES HOLZHEIZKESSELS AN EINE HEIZANLAGE MIT GESCHLOSSENEM GEFÄSS

LEGENDA

- | | | | |
|---|---|---|--|
| ① |  Tubazione di mandata e ritorno realizzata in acciaio nero posata a vista con specificato il diametro nominale e lo spessore dell'isolamento in mm. | ⑥ |  Valvola a sfera |
| ② |  Tubazione di adduzione idrica realizzata in multistrato posata a vista o a parete con specificato il diametro nominale e lo spessore dell'isolamento in mm. | ⑦ |  Valvola di ritegno tipo Europa |
| ③ |  Termostato di minima tarato a 60 °C | ⑧ |  Scarico convogliato |
| ④ |  Manometro da condotta | ⑨ |  Valvola di scarico termico |
| ⑤ |  Termometro da condotta | ⑩ |  Filtro a Y in bronzo filettato |
| | | ⑪ |  Valvola di sicurezza |
| | | ⑫ |  Vaso ad espansione |

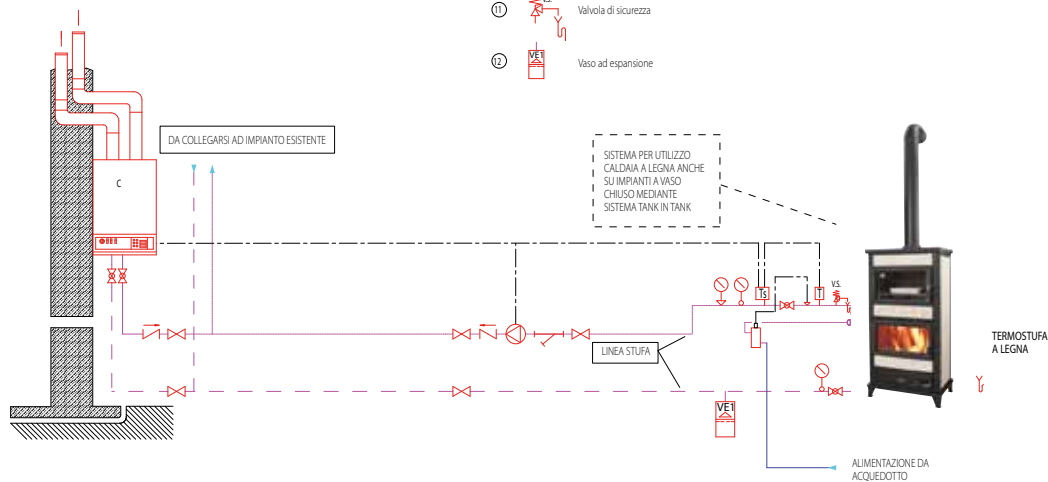

SCHEMA TIPO PER ALLACCIAMENTO CALDAIA A TERMOSTUFA A LEGNA, SERBATOIO DI ENERGIA, CON INTEGRAZIONE SOLARE, ALIMENTAZIONE IMPIANTO DI RISCALDAMENTO E SANITARIO A VASO APERTO

STANDARD DIAGRAM FOR BOILER CONNECTION TO THERMO STOVE, ENERGY TANK, INTEGRATED SOLAR POWER SYSTEM AND SUPPLY LINE FOR HEATING AND DOMESTIC HOT WATER SYSTEM WITH OPEN EXPANSION TANK

SCHEMA DE PRINCIPLE DU RACCORDEMENT DE LA CHAUDIERE SUR UN POÊLE À EAU CHAUDE FONCTIONNANT AU BOIS, AVEC RÉSERVOIR D'ÉNERGIE, INTÉGRATION SOLAIRE, ALIMENTATION DE L'INSTALLATION DE CHAUFFAGE ET D'EAU CHAUDE SANITAIRE À VASE D'ÉXPANSION OUVERT

PLANBEISPIEL FÜR DEN ANSCHLUSS DES HOLZHEIZKESSELS AN EINEN ENERGIESPEICHER MIT SOLARINTEGRATION FÜR HEIZUNG UND BRAUCHWASSER

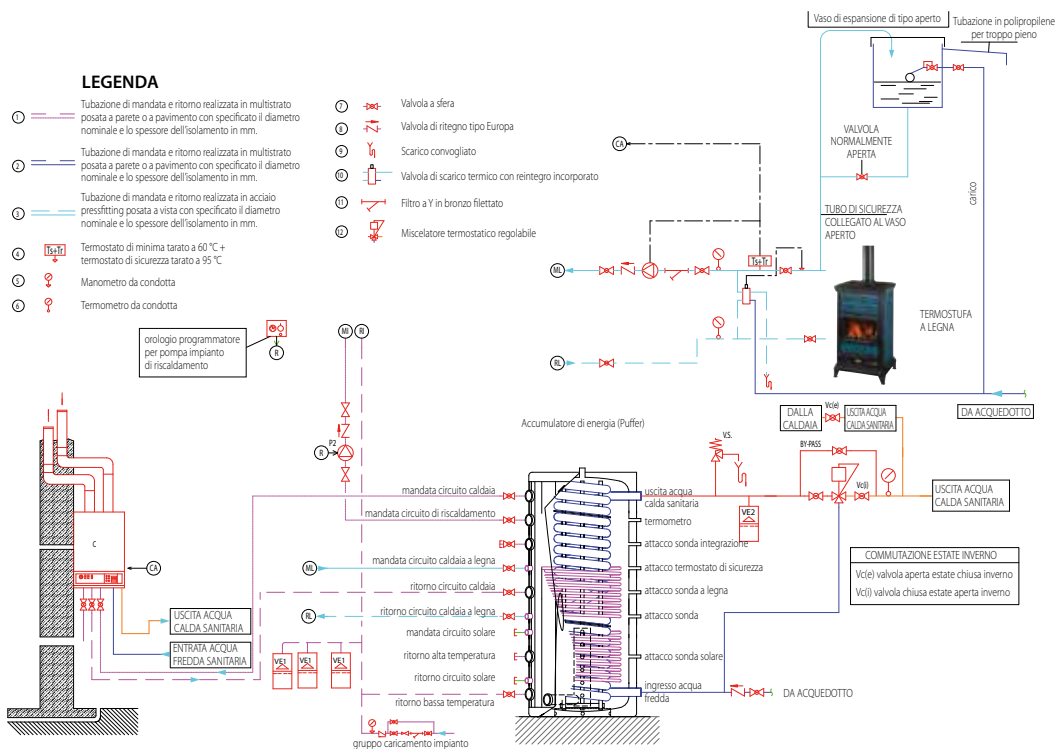

SCHEMI DI STUFE WEKOS CON VENTILAZIONE FORZATA

SCHEMES OF WEKOS' STOVES WITH FORCED AIR VENTILATION SYSTEMS

SCHEMAS DE POÊLES WEKOS AVEC VENTILATION FORCÉE

ENTWURF VON WEKOS-ÖFEN MIT VENTILATOR

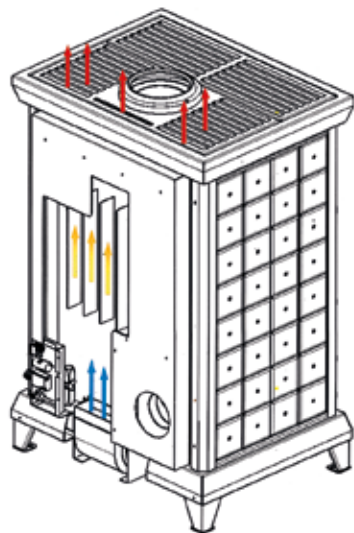

Esempio di stufa con ventilazione forzata.

Example of stove with forced air ventilation system.

Exemple de poêle avec ventilation forcée.

Beispiel: Kaminofen mit Ventilator.

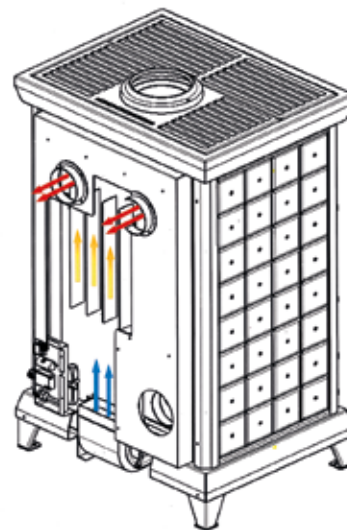

Esempio di stufa con ventilazione forzata e convogliazione aria posteriore. Si possono mettere 1 o 2 bocchette diametro 120 mm.

Example of stove with forced air ventilation system and rear air conveyor. It can be equipped with 1 or 2 120 mm diameter vents.

Exemple de poêle avec ventilation forcée et convoyage air postérieure. Il peut être équipé de 1 ou 2 buses de 120 mm de diamètre.

Beispiel: Kaminofen mit Ventilator und Luftstrom hinten. 1 oder 2 Stutzen mit Durchmesser von 120 mm können angebracht werden



Rev. 06/2020

Tutti i dati tecnici sono indicativi. L'azienda costruttrice si riserva di apporre modifiche senza alcun preavviso.

All technical data are indicative. The manufacturer reserves the right to make changes without prior notice.

Toutes les données techniques sont indicatives. Le constructeur se réserve le droit d'apporter des modifications sans aucun préavis.

Alle Daten und Angaben sind indikativ und ohne Gewähr. Die Herstellerfirma kann jederzeit ohne Vorankündigung Änderungen vornehmen.

MADE IN ITALY

lime&co



WEKOS S.r.l.

Via dell'Industria, 18

37066 Sommacampagna (Verona)

Tel. +39 045 8960108

Fax +39 045 8960725

www.wekos.it - wekos@wekos.it

